

**MISSION DATA CARD**

| OPORD     |                   | Callsign |  | Mission  |     | Date/Time   |       |
|-----------|-------------------|----------|--|----------|-----|-------------|-------|
| 3345/2024 |                   | T-Rex 2  |  | Training |     | 212030OCT24 |       |
| Task      | Dumb Bombs Strafe |          |  |          |     | Freq        |       |
| AO        | R63               |          |  |          |     | 132.25      |       |
| Departure |                   |          |  | Recovery |     |             |       |
| FYTTR LOW |                   |          |  | STRYK    |     |             |       |
| #         | Callsign          | Pilot    |  | IFF      | TCN | LSR         | NET   |
| -1        | T-Rex 2-1         | Crusader |  | 1521     | 1Y  | 1651        | 25/01 |
| -2        | T-Rex 2-2         | addiks   |  | 1522     | 64Y | 1652        | 25/02 |
| -3        | T-Rex 2-3         | Lenzi    |  | 1523     | 64X | 1653        | 25/03 |
| -4        | T-Rex 2-4         | Stoner   |  | 1524     | 1X  | 1654        | 25/04 |

**LOADOUT**

|     |               |      |         |
|-----|---------------|------|---------|
| A/A | A9M           | GUN  | 100% CM |
| A/G | 7M282L, 6xM82 | CHF  | 0       |
| POD | A184, TGP     | FLR  | 480     |
| TKS |               | FUEL | 80%     |

**TOLD**

|      |         |        |       |       |      |
|------|---------|--------|-------|-------|------|
|      | Takeoff | Target | Joker | Bingo | Land |
| FUEL | 8869    |        |       |       |      |

**AIRBASES**

|     | Name       | TCN | ATIS   | GND   | TWR   | RWY | Elev | ILS   |
|-----|------------|-----|--------|-------|-------|-----|------|-------|
| Dep | Nellis AFB | 12X | 270.1  | 275.8 | 327.0 | 21L | 1850 | 109.1 |
| Arr | Nellis AFB | 12X | 270.1  | 275.8 | 327.0 | 21L | 1850 | 109.1 |
| Div | Creech AFB | 87X | 290.45 | 275.8 | 360.6 |     |      |       |

**FLIGHTPLAN**

| # | Name      | Navaid/Coords/DME                   | ALT   | TOT |
|---|-----------|-------------------------------------|-------|-----|
| 1 | FYTTR     | LSV 269/33 (N36 21.440 W115 41.470) | 12000 |     |
| 2 | R63 Tower | INS 067/8 (N36 37 W115 30.200)      |       |     |
| 3 | STRYK     | LSV 282/26 (N36 25.620 W115 30.700) | 10000 |     |
| 4 | GASS PEAK | LSV 309/12 (N36 24.140 W115 10.660) | 8500  |     |
| 5 | APEX      | LSV 027/09 (N36 21.580 W114 54.340) |       |     |
| 6 | Nellis    | N36 14.680 W115 01.500              |       |     |

**COMMS**

| Radio | Usage                        |
|-------|------------------------------|
| 1     | 132.25                       |
| 2     | 11 - 3 - 4 - 16 - 11 - 4 - 3 |
| 3     | 32.00                        |

## NOTES

R63 361.600

**SUPPORT****Tanker**

| Callsign | TCN                                | Freq   | ALT   | TAS |
|----------|------------------------------------|--------|-------|-----|
| TEXACO 3 | 22Y                                | 300.05 | 15000 | 280 |
| Pos      | AR-231V: BTY 126/37 (N3620 W11614) |        |       |     |

## OTHER FLIGHTS

| Callsign    | Mission          | Airframe   | Freq                             | TCN  | Grpld | Laser |
|-------------|------------------|------------|----------------------------------|------|-------|-------|
| Edelweiss 5 | Training         | 2x F/A-18C | 134.55                           | 1/64 | 41    | 167X  |
| AO          | Red Corridor     | Task       | Fam Flight                       |      |       |       |
| Edelweiss 7 | Training         | 2x F/A-18C | 134.75                           | 1/64 | 41    | 167X  |
| AO          | Blue Corridor    | Task       | Fam Flight                       |      |       |       |
| Raptor 1    | Training         | 2x F-16C   | 134.0                            | 1/64 |       | 162X  |
| AO          | R66 / Leach Lake | Task       | MAV Training                     |      |       |       |
| Joker* 1    | Training         | 1x Ground  | 348.7                            | 1/64 |       | 170X  |
| AO          | R66 / Leach Lake | Task       | Range Control - Callsign: JOSHUA |      |       |       |
| Rattler 1   | Training         | 4x AH-64D  | 133.5                            | 1/64 |       | 125X  |
| AO          | LATNG            | Task       | Radar-Training                   |      |       |       |
| Raptor 2    | Training         | 2x F-16C   | 134.5                            | 1/64 |       | 163X  |
| AO          | R66 / Leach Lake | Task       | MAV Training                     |      |       |       |

**RADIO CHANNELS**

| #  | Freq    | Name                           |
|----|---------|--------------------------------|
| 1  |         | Flight/Squadron specific       |
| 2  | 289.4   | Nellis Clearance Delivery      |
| 3  | 275.8   | Nellis Ground                  |
| 4  | 327.0   | Nellis Tower                   |
| 5  | 385.4   | Nellis Approach/Departure West |
| 6  | 273.55  | Nellis Approach/Departure East |
| 7  | 317.525 | Nellis Control -- Sally        |
| 8  | 254.4   | Nellis Control-- Lee           |
| 9  | 305.6   | SOF Bullseye                   |
| 10 | 343.725 | EMERGENCY SINGLE FRQ           |
| 11 | 270.1   | Nellis ATIS                    |
| 12 | 360.625 | Creech AFB Tower               |
| 13 | 250.1   | HAVE QUICK 13                  |
| 14 | 251.1   | HAVE QUICK 14                  |
| 15 | 252.1   | HAVE QUICK 15                  |
| 16 | 377.8   | Blackjack                      |
| 17 | 265.0   | KC-135 AR-641A                 |
| 18 | 360.8   | KC-135MPRS AR-635              |
| 19 | 319.8   | KC-135MPRS AR-625              |
| 20 | 300.05  | KC-135 AR-231V                 |

**RAMROD**

|   |   |   |   |   |   |   |   |   |   |
|---|---|---|---|---|---|---|---|---|---|
| 0 | 1 | 2 | 3 | 4 | 5 | 6 | 7 | 8 | 9 |
| M | I | S | F | O | R | T | U | N | E |

**KTC 1400 C**

|   | 0    | 1   | 2   | 3  | 4  | 5   | 6  | 7  | 8  | 9  |
|---|------|-----|-----|----|----|-----|----|----|----|----|
| A | MOVJ | PGT | QAS | KY | HC | IUB | RX | FL | WD | NE |
| B | XDYF | KTQ | MJS | OE | PI | NAB | VU | GH | WR | LC |
| C | WCID | PHR | FOV | YJ | NG | MEB | AL | QT | XK | SU |
| D | GQAY | UKW | MTJ | BF | PC | HID | RX | SL | VO | EN |
| E | LJPQ | EXF | URK | OD | YV | AHN | BI | TM | WG | SC |
| F | MHBP | LJG | XIU | TV | DS | KRN | FQ | AY | EW | CO |
| G | AEWJ | UPD | XBK | CN | FY | TLS | RO | IG | HM | VQ |
| H | HLBX | FYN | MDS | VJ | QA | EUO | WK | RP | GC | IT |
| I | PONJ | LUW | CBQ | RF | GK | MHI | DX | YE | VT | AS |
| J | YGTC | PKM | JIN | VL | HA | QWO | EU | FX | DB | RS |
| K | GEVR | KNX | UOL | DJ | HA | MYB | SW | IQ | CT | FP |
| L | TGWU | YPA | KBL | XD | FO | EMR | QN | SH | IJ | VC |
| M | YQWF | CUG | HTX | LM | AO | NES | JD | VK | IB | RP |
| N | LEDS | GIP | WRO | TV | QB | NJU | KC | HX | FY | MA |
| O | OCWF | TGH | DBA | YM | RP | VJS | UE | IL | KX | QN |
| P | OGLE | YAH | TBS | QR | DX | JPM | IC | VW | KN | FU |
| Q | UIRM | BLO | VKY | CS | AJ | FTD | XQ | GP | NE | HW |
| R | AGRM | KLB | XCN | WY | DS | FJE | TO | VQ | UP | HI |
| S | FSIX | ORY | PMH | NB | UV | GCD | QL | JW | EK | TA |
| T | BQYM | PRT | NWF | EA | GH | OJS | UX | IV | DC | LK |
| U | VEKQ | UCH | NTW | RG | IP | FXA | OB | MD | JY | LS |
| V | TWPH | SNV | JGR | LE | OA | BIY | XQ | FD | UC | MK |
| W | JWQG | YOA | NIC | UB | RL | TEX | FD | PS | MV | HK |
| X | JLTQ | POK | SNH | WD | FV | MYX | AU | CB | GE | RI |
| Y | DOEW | VTJ | NRL | QC | XY | AFS | KI | GU | PB | MH |

**NAVAIDS**

| <b>Id</b> | <b>Name</b>   | <b>Channel</b> | <b>Position</b>    | <b>Elevation</b> |
|-----------|---------------|----------------|--------------------|------------------|
| BCE       | Bryce Canyon  | 75             | N3741.35 W11218.23 | 9040             |
| BIH       | Bishop        | 33             | N3722.62 W11821.99 | 4114             |
| BLD       | Boulder       | 114            | N3559.75 W11451.82 | 3650             |
| BTY       | Beatty        | 94             | N3648.54 W11644.86 | 2925             |
| CDC       | Cedar City    | 120            | N3747.24 W11304.90 | 5463             |
| DAG       | Daggett       | 79             | N3457.75 W11634.69 | 1760             |
| EED       | Needles       | 99             | N3445.96 W11428.43 | 650              |
| GFS       | Goffs         | 91             | N3507.87 W11510.59 | 4019             |
| GRL       | Groom Lake    | 18             | N3713.91 W11548.16 | 4475             |
| HEC       | Hector        | 74             | N3447.83 W11627.78 | 1854             |
| ILC       | Wilson Creek  | 110            | N3815.02 W11423.65 | 9318             |
| INS       | Creech AFB    | 87             | N3635.20 W11540.12 | 3101             |
| LAS       | McCarran Intl | 116            | N3604.78 W11509.59 | 2142             |
| LSV       | Nellis        | 12             | N3614.68 W11501.50 | 1864             |
| MLF       | Milford       | 58             | N3821.62 W11300.79 | 4977             |
| MMM       | Mormon Mesa   | 90             | N3646.16 W11416.65 | 2120             |
| MVA       | Mina          | 98             | N3833.92 W11801.97 | 7860             |
| OAL       | Coale Dale    | 124            | N3800.20 W11746.23 | 4800             |
| PGS       | Peach Springs | 57             | N3537.48 W11332.67 | 4754             |
| TPH       | Tonopah Muni  | 119            | N3801.84 W11702.01 | 5330             |
| TQQ       | Silverbow     | 77             | N3748.00 W11647.00 | 5500             |
| UTI       | St George     | 23             | N3705.29 W11335.53 | 2871             |



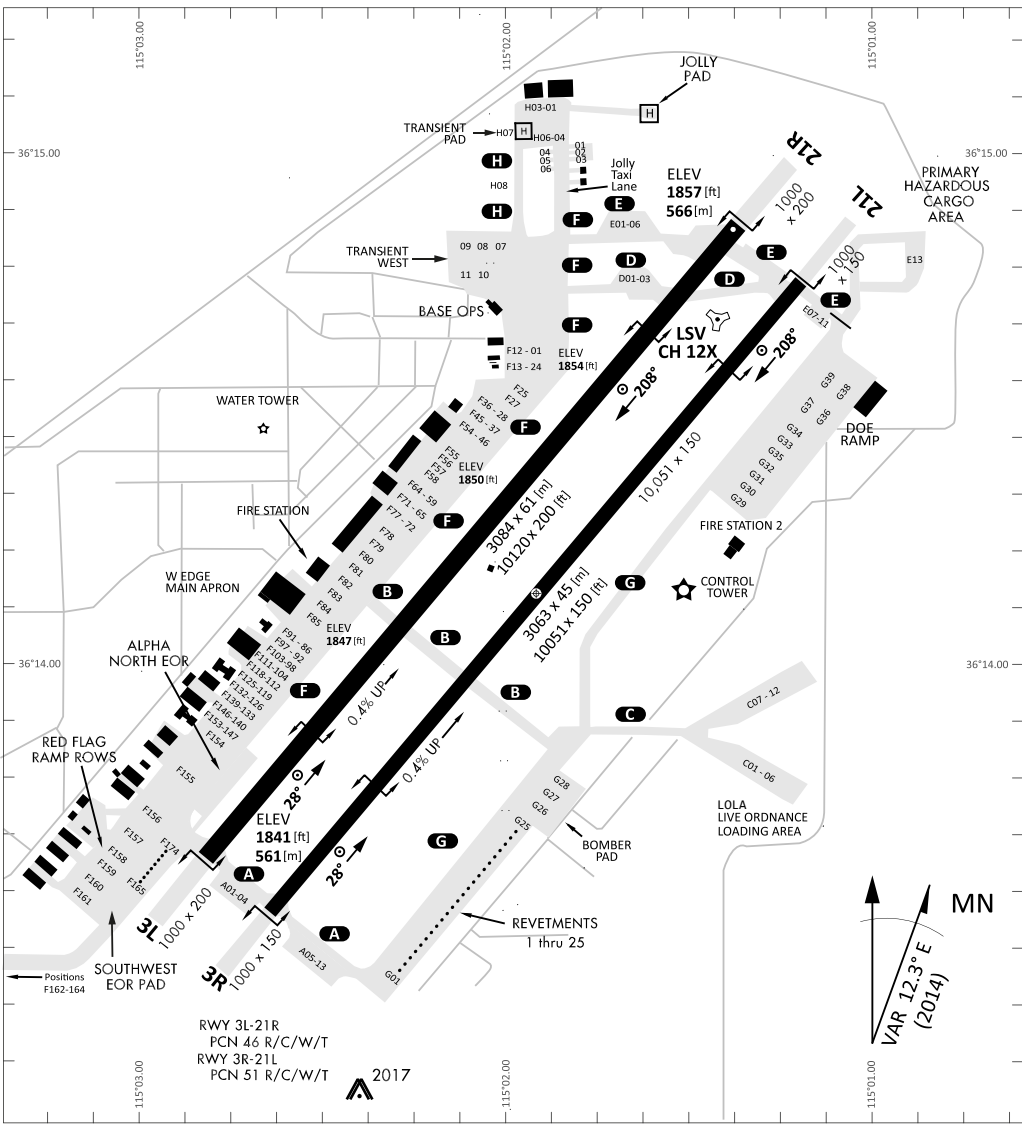

RWY 3L-21R  
 PCN 46 R/C/W/T  
 RWY 3R-21L  
 PCN 51 R/C/W/T  
 2017

| PAR | RWY | CAT     | MINIMA         |                     | ARP                             | ELEV                 | Scale 1:35'500                  |  |
|-----|-----|---------|----------------|---------------------|---------------------------------|----------------------|---------------------------------|--|
|     | 21L | A B D E | 2057 - 0.8 200 | (200-0.8/1.6) GS 3° | 36° 14.060° N<br>115° 01.058° W | 1857 [ft]<br>566 [m] | 0 300 600 900 1200 1500 [m]     |  |
|     | 3R  | A B D E | 2057 - 0.8 200 | (200-0.8/1.6) GS 3° |                                 |                      | 0 1000 2000 3000 4000 5000 [ft] |  |
| SRA | 21R | A C D E | 2257 - 1.2 350 | (350-1.2/1.6)       |                                 |                      |                                 |  |
|     | 3L  | A C D E | 2257 - 1.2 350 | (350-1.2/1.6)       |                                 |                      |                                 |  |

| RWY | TORA                | TODA                | ASDA                | LDA                 | PSN          | THR           | ALS |
|-----|---------------------|---------------------|---------------------|---------------------|--------------|---------------|-----|
| 21L | 10051 [ft] 3063 [m] | 11051 [ft] 3368 [m] | 11051 [ft] 3368 [m] | 10051 [ft] 3063 [m] | 36°14.043' N | 115°01.018' W | ⊕   |
| 3R  | 10120 [ft] 3084 [m] | 11120 [ft] 3398 [m] | 11120 [ft] 3398 [m] | 10120 [ft] 3084 [m] | 36°13.029' N | 115°02.038' W |     |
|     |                     |                     |                     |                     |              |               |     |
|     |                     |                     |                     |                     |              |               |     |

| ATIS        | NELLIS GROUND     | NELLIS TOWER     | NELLIS CONTROL | TACAN   | ILS RWY 21L | NELLIS EAST | NELLIS WEST |
|-------------|-------------------|------------------|----------------|---------|-------------|-------------|-------------|
| 270.100 MHz | 275.800   121.800 | 327.000   132.55 | 317.525        | LSV 12X | 109.10 Mhz  | 384.400     | 385.000     |

# FYTTR LOW VISUAL OPERATION CHART | VALID 2014

ATIS  
270.100  
NELLIS GROUND  
275.800  
NELLIS TOWER  
327.000  
NELLIS CONTROL  
317.525  
NELLIS DEP/APP EAST  
384.400  
BLACKJACK  
377.800

CAUTION: If unable to comply with restrictions advise ATC prior to departure.



## VMC ONLY

### PILOT RESPONSIBLE FOR TERRAIN AVOIDANCE

① 4 NM from RWY 3L/R

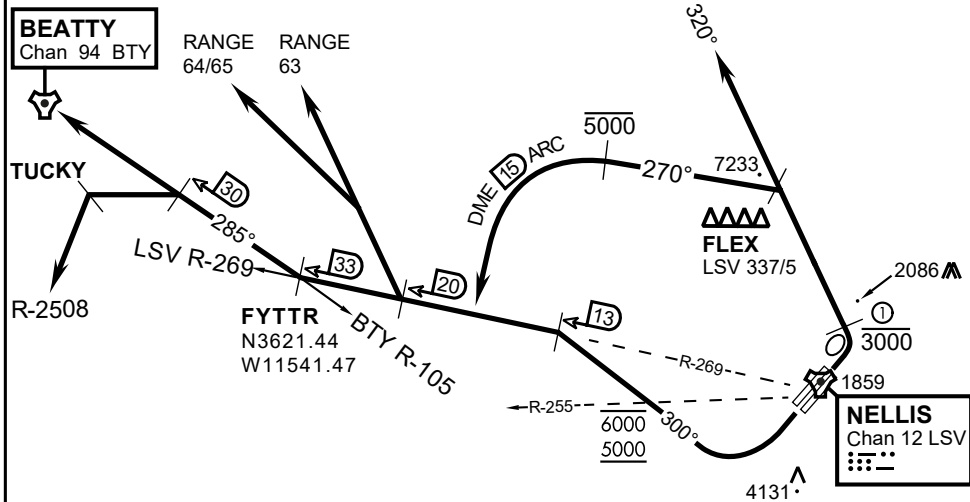

### DEPARTURE ROUTE DESCRIPTION

#### TAKEOFF RWY 3L/R:

- Remain below 3,000' MSL until north of Race Track and turned westbound.
- Turn left within 4NM of Nellis direct FLEX. Fly north of FLEX and turn left heading 270°.
- Intercept LSV 15 DME ARC at or below 5,000' MSL.
- ARC south, intercept LSV R-269 outbound. Maintain VFR.

#### TAKEOFF RWY 21L/21R:

- Follow Noise Abatement Procedures.
- Fly runway heading until past Golf Course, turn right heading 300°.
- Cross LSV R-255 between 5,000' and 6,000' , intercept and proceed outbound on the LSV R-269.Recommend climb to 8,500' MSL or appropriate VFR altitude for overflight of North Las Vegas Training Area. Fly routing for appr. mission/transition.

#### TRANSITIONS:

- R-4806:** Turn right at the LSV 269/20 direct to assigned ranges.
- BEATTY:** Turn right at FYTTR direct BTY via the BTY R-105
- R-2508:** Turn right at the FYTTR, intercept the BTY 105/30, direct TUCKY, then direct R-2508

## FYTTR DEPARTURE AND TRANSITIONS (FYTTR LOW)

v.15 13NOV20 NTRR NAV CHART

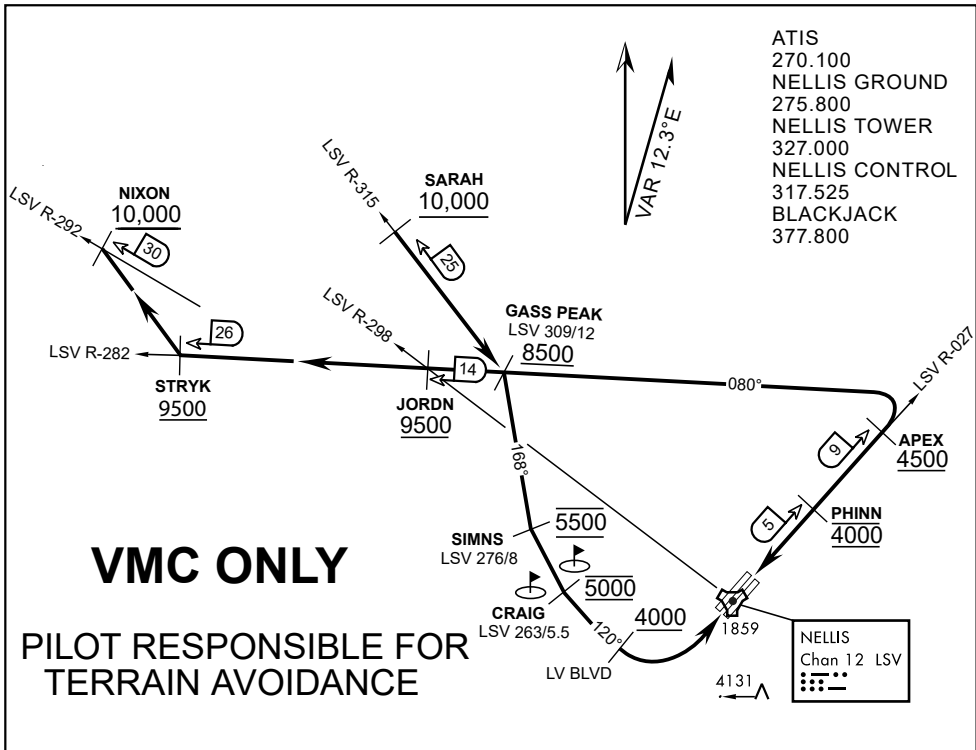

**APPROACH ROUTE DESCRIPTION**

**APPROACH RWY 3L/R**

Cross STRYK at or above 9,500' MSL, proceed direct GASS PEAK. Cross JORDN at or above 9,500' MSL, cross GASS PEAK at or above 8,500' MSL. Proceed direct SIMNS and cross at 5,500' MSL. Cross Las Vegas Blvd at or above 4,000' MSL then to 3,500' MSL for Initial. Remain within 4 DME if LSV on turn to final.

**VFR STRAIGHT-IN RWY 3L/R**

Depart CRAIG & descend to be at 3,000' MSL by Las Vegas Blvd. Do not descend below 3,000' MSL until within 5 DME of LSV or 4 NM of the runway on turn to final.

**APPROACH RWY 21L/R**

Cross STRYK at or above 9,500' MSL, proceed direct GASS PEAK. Cross JORDN at or above 9,500' MSL, cross GASS PEAK at or above 8,500' MSL. Cross APEX at or above 4,500' MSL then direct 5NM initial. Descend to cross PHINN at 4,000' MSL, Inside 5 NM descend to 3,500' MSL.

**VFR STRAIGHT-IN RWY 21L/R**

Cross APEX at 4,000' MSL. Descend to be at 3,000' MSL at PHINN. Descend to 3,000' MSL at LSV 027/5.

**RANGE 63B EXIT**

**SOUTH:** Via NIXON at or above 10,000' MSL, then direct STRYK.  
**EAST:** Via SARAH at or above 10,000' MSL, then direct GASS PEAK.



INDIAN SPRINGS, NEVADA

|                      |                  |                         |              |
|----------------------|------------------|-------------------------|--------------|
| TACAN INS<br>Chan 87 | APCH CRS<br>065° | Rwy ldg<br>TDZE<br>3133 | 9002<br>3113 |
|                      |                  | Arpt Elev<br>3113       |              |

INDIAN SPRINGS AF AUX (KINS)

**▽** \* MISSED APPROACH: Straight ahead to INS TACAN, intercept INS R-outbound, cross 17 DME at or above 9500, then direkt KSV TACAN 114

NELLIS CON

CREECH AFB TOWER  
118.30 60.60

GND CON

**NOT FOR CIVIL USE**

FOR USE UNDER BASIC VFR  
WEATHER MINIMUMS ONLY

PILOT IS RESPONSIBLE FOR TERRAIN/OBSTACLE AVOIDANCE AND APPROPRIATE VFR CLOUD CLEARANCE FOR ALL

**CAUTION:** Descent gradients are greater than allowed under standard TERPS criteria and inbound course does not meet straight-in criteria

**CAUTION:** Final approach course crosses Runway centerline at MIDFIELD. Maneuvering left of course required prior to landing. Do not Maneuver farther north than the INS R- 258

Modified by viaBog 66 for use with DCS  
NOT FOR REAL LIFE NAVIGATION

Modified by viaBog 66 for use with DCS  
NOT FOR REAL LIFE NAVIGATION

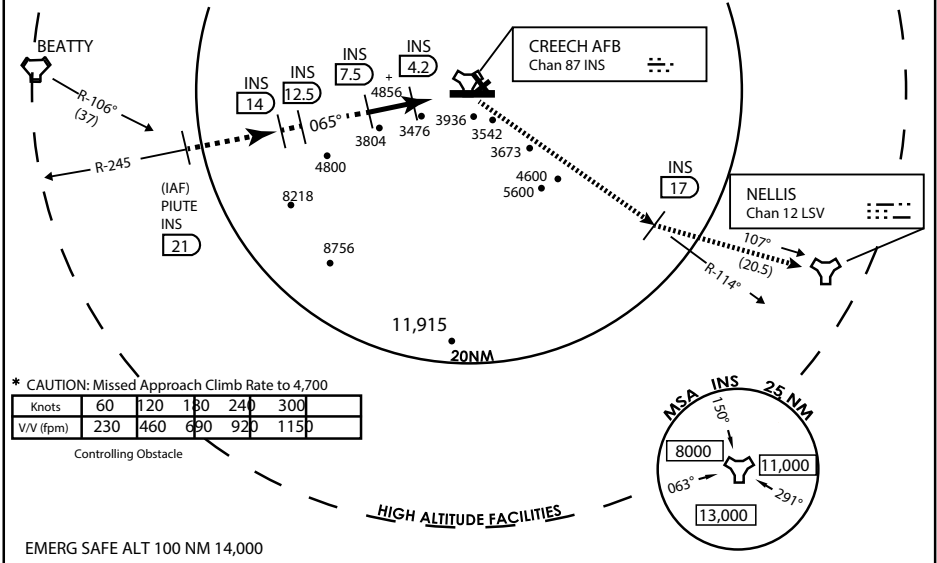

\* CAUTION: Missed Approach Climb Rate to 4,700

|           |     |     |     |     |      |
|-----------|-----|-----|-----|-----|------|
| Knots     | 60  | 120 | 180 | 240 | 300  |
| V/V (fpm) | 230 | 460 | 690 | 920 | 1150 |

Controlling Obstacle

HIGH ALTITUDE FACILITIES

EMERG SAFE ALT 100 NM 14,000

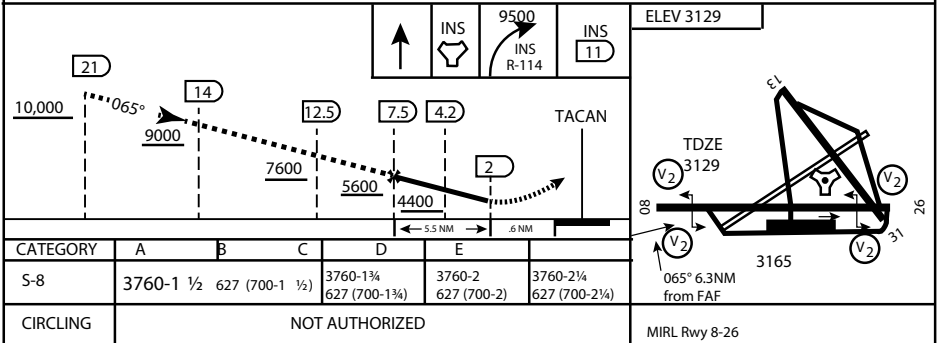

CITY OF INDIAN, NEVADA

INDIAN SPRINGS AF AUX (KINS)

(FOR DAY VFR USE ONLY)



