

MISSION DATA CARD

OPORD		Callsign		Mission		Date/Time	
3140/2024		Raptor 2		Training		262000AUG24	
Task	Tac Training					Freq	
AO	East NTTR					134.5	
Departure				Recovery			
FYTTR LOW				STRYK			
#	Callsign	Pilot	IFF	TCN	LSR	NET	
-1	Raptor 2-1	Hercules	1721	2Y	1701		
-2	Raptor 2-2	Butcher	1722	65Y	1702		
-3	Raptor 2-3	Woodman	1723	65X	1703		

LOADOUT

A/A	2xA120C, 2xA9X			GUN	100% HEI-T
A/G				CHF	120
POD				FLR	0
TKS	3xFT300			FUEL	100%

TOLD

	Takeoff	Target	Joker	Bingo	Land
FUEL	13172				

AIRBASES

	Name	TCN	ATIS	GND	TWR	RWY	Elev	ILS
Dep	Nellis AFB	12X	270.1	275.8	327.0	21L	1850	109.1
Arr	Nellis AFB	12X	270.1	275.8	327.0	21L	1850	109.1
Div	Creech AFB	87X	290.45	275.8	360.6			

FLIGHTPLAN

#	Name	Navaid/Coords/DME	ALT	TOT
1	DREAM	N37 10 20.400 W114 59 31.800	24000	
2	2	N37 52 W115 01 60	24000	
3	3	N37 52 00.640 W113 00 02.789	24000	
4	4	N36 59 55.118 W112 59 55.025	24000	
5	5	N37 00 10.995 W114 59 20.189	24000	
6	SARAH	N36 36 27 W115 18 01.800	15000	
7	GASS PEAK	N36 24 08.400 W115 10 39.600	8500	
8	SIMNS	N36 17 20.400 W115 10 45	5500	
9	CRAIG	N36 15 15 W115 08 16.200	5000	
10	Nellis AFB	N36 13 32 W115 02 37	4000	

SUPPORT**Tanker**

Callsign	TCN	Freq	ALT	TAS
TEXACO 2	95Y	289.7	FL220	420
Pos	Pegasus.1: CDC 166/102 (N3730 W11440)			

OTHER FLIGHTS

Callsign	Mission	Airframe	Freq	TCN	Grpld	Laser
T-Rex 2	Training	2x A-10C	132.25	1/64	25	165X
AO	AAR West of FYTTR	Task	AAR NCR			
Monster 2	Training	2x A-10C	131.25	1/64	21	165X
AO	R64	Task	AEP			
Raptor 1	Training	4x F-16C	134.0	1/64		170X
AO	East NTTR	Task	Tac Training			
Tiger 1	Training	4x F/A-18C	261.15	1/64		155X
AO	R65c	Task	Convoy Hunt			

RADIO CHANNELS

#	Freq	Name
1		Flight/Squadron specific
2	289.4	Nellis Clearance Delivery
3	275.8	Nellis Ground
4	327.0	Nellis Tower
5	385.4	Nellis Approach/Departure West
6	273.55	Nellis Approach/Departure East
7	317.525	Nellis Control -- Sally
8	254.4	Nellis Control-- Lee
9	305.6	SOF Bullseye
10	343.725	EMERGENCY SINGLE FRQ
11	270.1	Nellis ATIS
12	360.625	Creech AFB Tower
13	250.1	HAVE QUICK 13
14	251.1	HAVE QUICK 14
15	252.1	HAVE QUICK 15
16	377.8	Blackjack
17	265.0	KC-135 AR-641A
18	360.8	KC-135MPRS AR-635
19	319.8	KC-135MPRS AR-625
20	300.05	KC-135 AR-231V

RAMROD

0	1	2	3	4	5	6	7	8	9
D	E	P	I	L	A	T	O	R	Y

KTC 1400 C

	0	1	2	3	4	5	6	7	8	9
A	EIAR	BSC	MJG	TU	LO	DVX	WP	YH	QF	KN
B	GSTR	NQE	KBO	MA	IP	WVC	DY	FL	JX	HU
C	AJRH	TGU	FNE	PY	QC	DVL	IM	BS	XW	KO
D	IBAT	LOP	QSK	YR	UD	NVM	XG	WC	JF	HE
E	IXEL	YBN	QUA	CT	HF	DMV	KO	RJ	PG	SW
F	SPNR	VTG	YIB	CD	MW	UOX	EK	FJ	LQ	AH
G	YKLV	SFX	WCB	AU	DT	NGR	JI	QE	OH	MP
H	CNJO	BLF	TEW	PS	YQ	IDV	XG	MU	AK	RH
I	QUNJ	XOH	FBD	WL	YG	PCE	VI	RK	AM	ST
J	OSTH	YRN	QIJ	UP	KA	VEC	DG	FB	MX	LW
K	RDFP	XGO	KJA	WN	MQ	CHT	VB	EU	LI	SY
L	NGKL	OMD	HBA	RC	YQ	UVJ	XP	FS	EW	TI
M	DRGJ	POK	MHU	ES	AX	VWF	NI	YT	CL	QB
N	UVME	AXY	IOB	WS	GK	CTP	JD	FH	RL	NQ
O	BXMP	TSG	OJK	UW	EI	LCV	NY	RF	QD	AH
P	VWKB	CIN	UAY	LQ	MT	HDO	SJ	XF	PG	RE
Q	FDXV	LSH	CIG	YR	JQ	ETM	PN	AW	KB	UO
R	RJHW	VNE	TBD	IK	QO	LGX	UF	CM	YS	PA
S	VGWB	DSY	LAR	MF	CO	ENX	HT	PQ	JU	KI
T	LDCW	MNG	HPJ	KE	TB	AOU	FX	RS	QV	YI
U	CFUR	GXQ	HVL	JY	NO	KPE	MA	IT	DW	BS
V	GDNY	WOH	LET	JR	MF	BXA	CV	QI	PS	UK
W	NOJQ	VLY	XDE	GA	FC	HST	UI	PB	KM	WR
X	DCLE	BPT	MHA	IX	WQ	UGV	SN	OR	KJ	YF
Y	ULPR	NMB	QEF	IW	XC	VHG	SO	KD	JT	AY

NAVAIDS

Id	Name	Channel	Position	Elevation
BCE	Bryce Canyon	75	N3741.35 W11218.23	9040
BIH	Bishop	33	N3722.62 W11821.99	4114
BLD	Boulder	114	N3559.75 W11451.82	3650
BTY	Beatty	94	N3648.54 W11644.86	2925
CDC	Cedar City	120	N3747.24 W11304.90	5463
DAG	Daggett	79	N3457.75 W11634.69	1760
EED	Needles	99	N3445.96 W11428.43	650
GFS	Goffs	91	N3507.87 W11510.59	4019
GRL	Groom Lake	18	N3713.91 W11548.16	4475
HEC	Hector	74	N3447.83 W11627.78	1854
ILC	Wilson Creek	110	N3815.02 W11423.65	9318
INS	Creech AFB	87	N3635.20 W11540.12	3101
LAS	McCarran Intl	116	N3604.78 W11509.59	2142
LSV	Nellis	12	N3614.68 W11501.50	1864
MLF	Milford	58	N3821.62 W11300.79	4977
MMM	Mormon Mesa	90	N3646.16 W11416.65	2120
MVA	Mina	98	N3833.92 W11801.97	7860
OAL	Coale Dale	124	N3800.20 W11746.23	4800
PGS	Peach Springs	57	N3537.48 W11332.67	4754
TPH	Tonopah Muni	119	N3801.84 W11702.01	5330
TQQ	Silverbow	77	N3748.00 W11647.00	5500
UTI	St George	23	N3705.29 W11335.53	2871

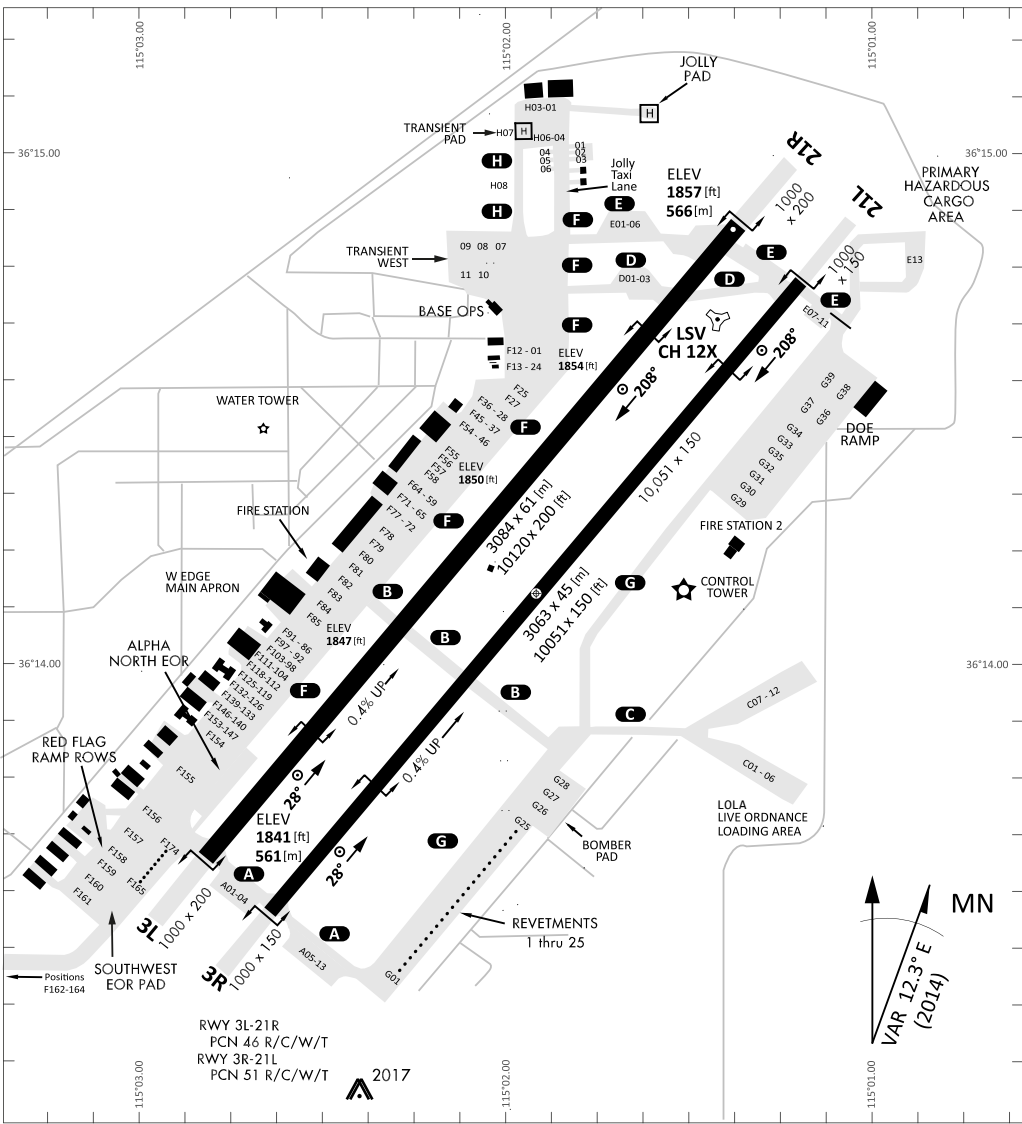

RWY 3L-21R
PCN 46 R/C/W/T
RWY 3R-21L
PCN 51 R/C/W/T

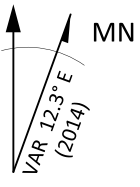

PAR	RWY	CAT	MINIMA	ARP	ELEV	Scale
	21L	A B D E	2057 - 0.8 200 (200-0.8/1.6) GS 3°	36° 14.060° N	1857 [ft]	0 300 600 900 1200 1500 [m]
	3R	A B D E	2057 - 0.8 200 (200-0.8/1.6) GS 3°	115° 01.058° W	566 [m]	0 1000 2000 3000 4000 5000 [ft]
SRA	21R	A C D E	2257 - 1.2 350 (350-1.2/1.6)			
	3L	A C D E	2257 - 1.2 350 (350-1.2/1.6)			

RWY</

FYTTR LOW VISUAL OPERATION CHART | VALID 2014

ATIS
270.100
NELLIS GROUND
275.800
NELLIS TOWER
327.000
NELLIS CONTROL
317.525
NELLIS DEP/APP EAST
384.400
BLACKJACK
377.800

CAUTION: If unable to comply with restrictions advise ATC prior to departure.



VMC ONLY

PILOT RESPONSIBLE FOR TERRAIN AVOIDANCE

① 4 NM from RWY 3L/R

BEATTY
Chan 94 BTY

RANGE 64/65
RANGE 63

TUCKY

R-2508

LSV R-269

FYTTR
N3621.44
W11541.47

BTY R-105

DME 15 ARC
5000

270°

7233

FLEX
LSV 337/5

2086 M

①

3000

NELLIS
Chan 12 LSV

1859

4131

v.130602 NITR NAV CHART

DEPARTURE ROUTE DESCRIPTION

TAKEOFF RWY 3L/R:

- Remain below 3,000' MSL until north of Race Track and turned westbound.
- Turn left within 4NM of Nellis direct FLEX. Fly north of FLEX and turn left heading 270°.
- Intercept LSV 15 DME ARC at or below 5,000' MSL.
- ARC south, intercept LSV R-269 outbound. Maintain VFR.

TAKEOFF RWY 21L/21R:

- Follow Noise Abatement Procedures.
- Fly runway heading until past Golf Course, turn right heading 300°.
- Cross LSV R-255 between 5,000' and 6,000' , intercept and proceed outbound on the LSV R-269.Recommend climb to 8,500' MSL or appropriate VFR altitude for overflight of North Las Vegas Training Area. Fly routing for appr. mission/transition.

TRANSITIONS:

- R-4806:** Turn right at the LSV 269/20 direct to assigned ranges.
- BEATTY:** Turn right at FYTTR direct BTY via the BTY R-105
- R-2508:** Turn right at the FYTTR, intercept the BTY 105/30, direct TUCKY, then direct R-2508

FYTTR DEPARTURE AND TRANSITIONS (FYTTR LOW)

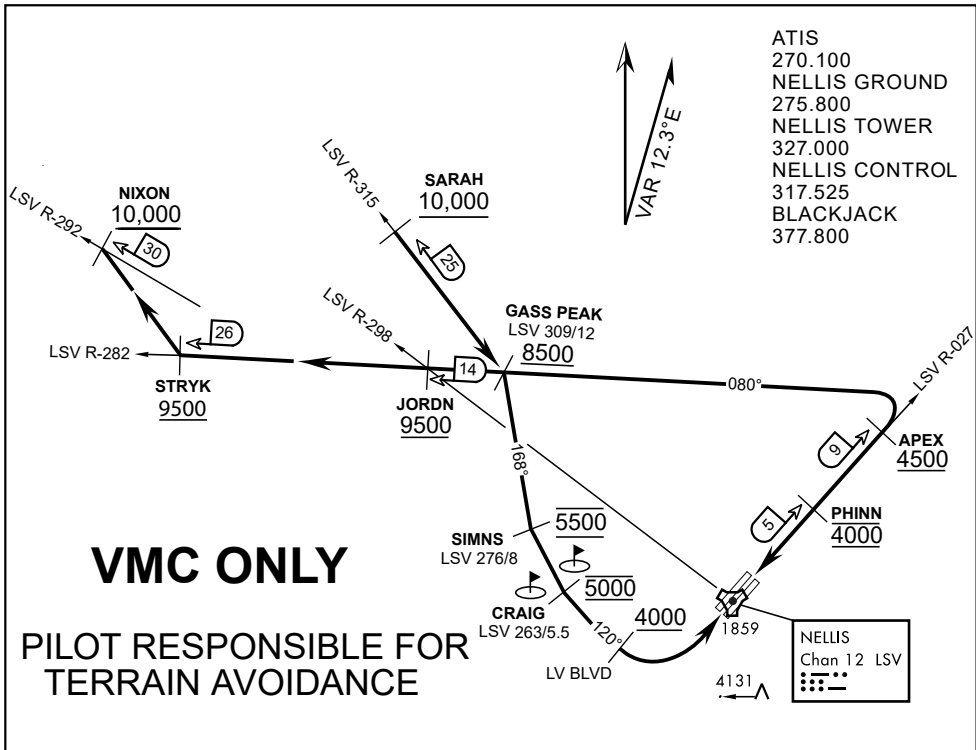

VMC ONLY
**PILOT RESPONSIBLE FOR
 TERRAIN AVOIDANCE**

APPROACH ROUTE DESCRIPTION

APPROACH RWY 3L/R

Cross STRYK at or above 9,500' MSL, proceed direct GASS PEAK. Cross JORDN at or above 9,500' MSL, cross GASS PEAK at or above 8,500' MSL. Proceed direct SIMNS and cross at 5,500' MSL. Cross Las Vegas Blvd at or above 4,000' MSL then to 3,500' MSL for Initial. Remain within 4 DME if LSV on turn to final.

VFR STRAIGHT-IN RWY 3L/R

Depart CRAIG & descend to be at 3,000' MSL by Las Vegas Blvd. Do not descend below 3,000' MSL until within 5 DME of LSV or 4 NM of the runway on turn to final.

APPROACH RWY 21L/R

Cross STRYK at or above 9,500' MSL, proceed direct GASS PEAK. Cross JORDN at or above 9,500' MSL, cross GASS PEAK at or above 8,500' MSL. Cross APEX at or above 4,500' MSL then direct 5NM initial. Descend to cross PHINN at 4,000' MSL, Inside 5 NM descend to 3,500' MSL.

VFR STRAIGHT-IN RWY 21L/R

Cross APEX at 4,000' MSL. Descend to be at 3,000' MSL at PHINN. Descend to 3,000' MSL at LSV 027/5.

RANGE 63B EXIT

SOUTH: Via NIXON at or above 10,000' MSL, then direct STRYK.
EAST: Via SARAH at or above 10,000' MSL, then direct GASS PEAK.



INDIAN SPRINGS, NEVADA

TACAN INS Chan 87	APCH CRS 065°	Rwy Idg 9002
		TDZE 3133
		Arpt Elev 3113

INDIAN SPRINGS AF AUX (KINS)

▼ * MISSED APPROACH: Straight ahead to INS TACAN, intercept INS R-outbound, cross 17 DME at or above 9500, then direkt KSV TACAN 114

NELLIS CON

CREECH AFB TOWER
118.30 60.60

GND CON

NOT FOR CIVIL USE

FOR USE UNDER BASIC VFR
WEATHER MINIMUMS ONLY

PILOT IS RESPONSIBLE FOR TERRAIN/OBSTACLE
AVOIDANCE AND
APPROPRIATE VFR CLOUD
CLEARANCE FOR ALL

CAUTION: Descent gradients are greater than allowed under standard TERPS criteria and inbound course does not meet straight-in criteria

CAUTION: Final approach course crosses Runway centerline at MIDFIELD. Maneuvering left of course required prior to landing. Do not Maneuver farther north than the INS R- 258

Modified by vJaBoG 66 for use with DCS
NOT FOR REAL LIFE NAVIGATION

Modified by vJaBoG 66 for use with DCS
NOT FOR REAL LIFE NAVIGATION

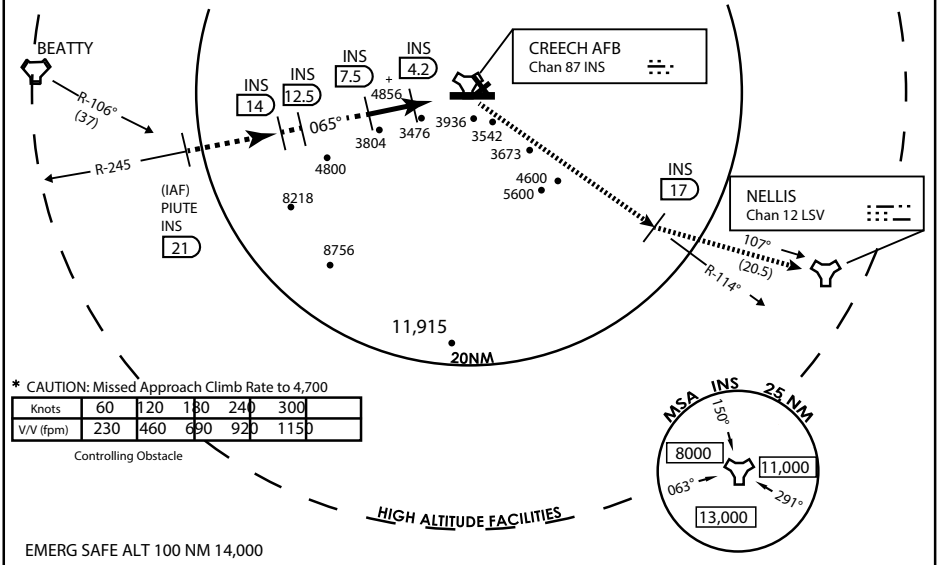

* CAUTION: Missed Approach Climb Rate to 4,700

Knots	60	120	180	240	300
V/V (fpm)	230	460	690	920	1150

Controlling Obstacle

HIGH ALTITUDE FACILITIES

EMERG SAFE ALT 100 NM 14,000

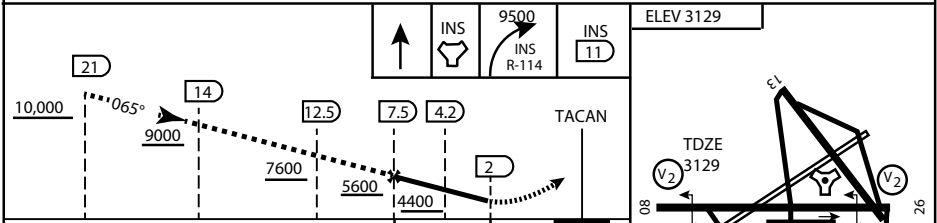

CATEGORY	A	B	C	D	E
S-8	3760-1 1/2	627 (700-1 1/2)	3760-1 3/4 627 (700-1 3/4)	3760-2 627 (700-2)	3760-2 1/4 627 (700-2 1/4)
CIRCLING	NOT AUTHORIZED				

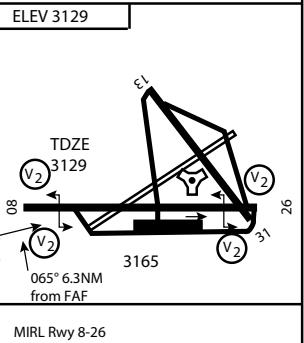

CITY OF INDIAN, NEVADA

INDIAN SPRINGS AF AUX (KINS)

(FOR DAY VFR USE ONLY)



AIRPORT DIAGRAM

476 VFG

CREECH AFB (KINS)
INDIAN SPRINGS, NEVADA

ATIS
 122.5
 CREECH TOWER
 118.4 360.7 38.65
 GND CON
 118.3 275.8
 CLNC DEL

115°42'W

FIELD
 ELEV
 3127

80

972 X 150

HOT CARGO PAD

BAK-12

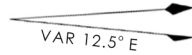
 VAR 12.5° E

WEST EOR

115°41'W

476 VFG JAN 2019

CONTROL TOWER
 BASE OPS

RPA LOLA WEST

RPA LOLA EAST

LOLA / HUNG ORDNANCE

199 X 100
 ELEV 3127
 RUNWAY 31/13
 MQ/RQ-1 ONLY

476 VFG JAN 2019

9002 X 150

258.5°

860 X 100

313.8°

4064 X 100

115°40'W

BAK-12

ELEV 3127

EAST EOR

1030 X 150

26

AIRPORT DIAGRAM

INDIAN SPRINGS, NEVADA
CREECH AFB (KINS)