

**MISSION DATA CARD**

OPORD		Callsign		Mission		Date/Time		
2900/2024		Raptor 1		Training		152000MAY24		
Task	66 - IFR Rumble					Freq		
AO	North of Nellis AFB					134.0		
Departure				Recovery				
DREAM FOUR				HI-ILS or LOC/DME Z RWY 21L				
#	Callsign		Pilot		IFF	TCN	LSR	NET
-1	Raptor 1-1		Cyking		1161	1Y	1661	40/01

**LOADOUT**

A/A		GUN	
A/G		CHF	
POD		FLR	
TKS		FUEL	

**TOLD**

	Takeoff	Target	Joker	Bingo	Land
FUEL	7163				

**AIRBASES**

	Name	TCN	ATIS	GND	TWR	RWY	Elev	ILS
Dep	Nellis AFB	12X	270.1	275.8	327.0	21L	1850	109.1
Arr	Nellis AFB	12X	270.1	275.8	327.0	21L	1850	109.1
Div	Creech AFB	87X	290.45	275.8	360.6			

**FLIGHTPLAN**

#	Name	Navaid/Coords/DME	ALT	TOT
1	HEREM	N36 22.521 W114 52.306		
2	JUNNO	BLD 346/44 (N36 43.800 W114 52.770)	17000	
3	CARPP	LSV 355/63 (N37 17 W114 50.720)	25000	
4	BIGHORN	LSV 347/97 (N37 52 W115 02)	45000	
5	DREAM	LAS 354/66 BLD 342/71 (N37 10.340 W114 59.530)	20000	
6	ARCOE	LSV 357/30 (N36 44.260 W114 55.020)	15000	
7	RONKY	N36 39.332 W114 56.110	15000	
8	WISTO	N36 35.388 W114 56.977	15000	
9	OLNIE	N36 34.989 W114 54.756	12500	
10	KRYSS	N36 30.369 W114 44.190	8900	
11	SHEET	N36 24.532 W114 50.652	5000	
12	ROTSE	N36 20.025 W114 55.561	4200	
13	JELIR	N36 17.482 W114 58.326	3140	
14	SESDE	N36 15.072 W115 00.943		
15	ROCKX	N36 12.819 W115 03.572		

## NOTES

Circ Del ~~2~~89.900

Ground ~~2~~75.900

Tower ~~3~~27.100

Departure ~~3~~85.400

CENTER ~~3~~43.700

Approach ~~2~~73.650

## OTHER FLIGHTS

Callsign	Mission	Airframe	Freq	TCN	Grpld	Laser
Panther 7	Training	1x F/A-18C	261.35	1/64		157X
AO		Task	66 - IFR			
Tiger 1	Training	1x F/A-18C	261.15	1/64	1	151X
AO		Task	66 - IFR			
Nazgul 6	Training	4x F-15E	262.45	1/64	40	166X
AO	North of Nellis AFB	Task	66 - IFR Rumble			
Rattler 5	Training	4x AH-64D	133.5	1/64		125X
AO	Nellis	Task	IFR Rumble			
Nazgul 7	Training	4x F-15E	262.45	1/64		156X
AO		Task	vJaboG66-IFR Rumble			
Zapper* 1	Training	1x A-10C	264.05	1/64		170X
AO	Nellis	Task	IFR Rumble			

**RADIO CHANNELS**

#	Freq	Name
1		Flight/Squadron specific
2	289.4	Nellis Clearance Delivery
3	275.8	Nellis Ground
4	327.0	Nellis Tower
5	385.4	Nellis Approach/Departure West
6	273.55	Nellis Approach/Departure East
7	317.525	Nellis Control -- Sally
8	254.4	Nellis Control-- Lee
9	305.6	SOF Bullseye
10	343.725	EMERGENCY SINGLE FRQ
11	270.1	Nellis ATIS
12	360.625	Creech AFB Tower
13	250.1	HAVE QUICK 13
14	251.1	HAVE QUICK 14
15	252.1	HAVE QUICK 15
16	377.8	Blackjack
17	265.0	KC-135 AR-641A
18	360.8	KC-135MPRS AR-635
19	319.8	KC-135MPRS AR-625
20	300.05	KC-135 AR-231V

**RAMROD**

0	1	2	3	4	5	6	7	8	9
I	M	P	R	O	V	A	B	L	E

**KTC 1400 C**

	0	1	2	3	4	5	6	7	8	9
A	SQJL	DOI	PRY	XH	NW	KCV	EF	BA	GT	MU
B	GUQJ	WFM	VKH	XA	PB	ERL	CO	NI	YD	TS
C	FOUQ	JCV	XGY	AK	HP	BDM	LR	EI	SW	TN
D	HEGU	JTX	YDF	WM	KN	QSA	LP	VO	CB	RI
E	SVQP	KEF	NDO	HX	CU	GMW	TI	BY	JA	LR
F	NPOM	RGK	CEB	YF	HW	IJL	QT	VS	XA	DU
G	NEIL	RDY	OUP	BV	KH	GTM	WQ	JC	AS	FX
H	EAJM	IPG	HVO	RC	SY	LKT	UN	BQ	XF	DW
I	RODP	HMI	VTX	JW	EA	FUK	SQ	NG	CL	BY
J	XENV	TUI	SLK	HJ	YW	QCA	GB	MP	DO	FR
K	AYIR	OCM	EGV	HL	PT	DNK	SF	XB	WJ	QU
L	RVJH	IAL	FNG	BO	DQ	TYE	WC	SU	KP	XM
M	VPWD	HAF	CXO	JY	BG	ISQ	KN	ER	LM	UT
N	SATF	RIV	KOM	XQ	GJ	HNP	UE	LW	BC	DY
O	EUNL	CMX	OWR	VQ	BD	PAK	TG	IH	JF	YS
P	UOJY	KMD	AQI	CB	LR	EHT	FV	SN	XG	WP
Q	LFHQ	KVY	PMC	AW	SR	BDX	TJ	GO	EU	NI
R	FBDM	JIL	NEY	UO	RV	WAX	GK	PS	TH	CQ
S	SOGK	IER	UNM	JP	VQ	WFA	YL	CX	TH	DB
T	CKYX	UJO	MTA	SV	EB	QPF	IG	WD	HN	LR
U	JLKA	FGU	BXN	PM	EI	TVD	SO	QC	HY	RW
V	NVFT	OHW	SAY	QU	KG	IRB	JX	CP	LM	ED
W	BTCQ	YLM	WPJ	SO	KG	RAV	XH	EN	DI	FU
X	FXBP	CTI	KRD	LQ	SG	UEO	MV	YJ	WA	HN
Y	VLPJ	MDY	BHF	XG	QA	IST	RK	EU	CO	WN

**NAVAIDS**

<b>Id</b>	<b>Name</b>	<b>Channel</b>	<b>Position</b>	<b>Elevation</b>
BCE	Bryce Canyon	75	N3741.35 W11218.23	9040
BIH	Bishop	33	N3722.62 W11821.99	4114
BLD	Boulder	114	N3559.75 W11451.82	3650
BTY	Beatty	94	N3648.54 W11644.86	2925
CDC	Cedar City	120	N3747.24 W11304.90	5463
DAG	Daggett	79	N3457.75 W11634.69	1760
EED	Needles	99	N3445.96 W11428.43	650
GFS	Goffs	91	N3507.87 W11510.59	4019
GRL	Groom Lake	18	N3713.91 W11548.16	4475
HEC	Hector	74	N3447.83 W11627.78	1854
ILC	Wilson Creek	110	N3815.02 W11423.65	9318
INS	Creech AFB	87	N3635.20 W11540.12	3101
LAS	McCarran Intl	116	N3604.78 W11509.59	2142
LSV	Nellis	12	N3614.68 W11501.50	1864
MLF	Milford	58	N3821.62 W11300.79	4977
MMM	Mormon Mesa	90	N3646.16 W11416.65	2120
MVA	Mina	98	N3833.92 W11801.97	7860
OAL	Coale Dale	124	N3800.20 W11746.23	4800
PGS	Peach Springs	57	N3537.48 W11332.67	4754
TPH	Tonopah Muni	119	N3801.84 W11702.01	5330
TQQ	Silverbow	77	N3748.00 W11647.00	5500
UTI	St George	23	N3705.29 W11335.53	2871



RWY 3L-21R  
 PCN 46 R/C/W/T  
 RWY 3R-21L  
 PCN 51 R/C/W/T  
 2017

PAR	RWY	CAT	MINIMA		ARP	ELEV	Scale 1:35'500	
	21L	A B D E	2057 - 0.8 200 (200-0.8/1.6)	GS 3°	36° 14.060° N 115° 01.058° W	1857 [ft] 566 [m]	0 300 600 900 1200 1500 [m]	
	3R	A B D E	2057 - 0.8 200 (200-0.8/1.6)	GS 3°			0 1000 2000 3000 4000 5000 [ft]	
SRA	21R	A C D E	2257 - 1.2 350 (350-1.2/1.6)					
	3L	A C D E	2257 - 1.2 350 (350-1.2/1.6)					

RWY	TORA	TODA	ASDA	LDA	PSN	THR	ALS
21L	10051 [ft] 3063 [m]	11051 [ft] 3368 [m]	11051 [ft] 3368 [m]	10051 [ft] 3063 [m]	36°14.043' N	115°01.018' W	⊕
3R	10120 [ft] 3084 [m]	11120 [ft] 3398 [m]	11120 [ft] 3398 [m]	10120 [ft] 3084 [m]	36°13.029' N	115°02.038' W	

ATIS	NELLIS GROUND	NELLIS TOWER	NELLIS CONTROL	TACAN	ILS RWY 21L	NELLIS EAST	NELLIS WEST
270.100 MHz	275.800   121.800	327.000   132.55	317.525	LSV 12X	109.10 Mhz	384.400	385.000



# DREAM FOUR DEPARTURE DREAM4 | VALID 2014

**NELLIS AFB (KLSV)**  
LAS VEGAS, NEVADA

ATIS  
270.100  
NELLIS GROUND  
275.800  
NELLIS TOWER  
327.000  
NELLIS CONTROL  
317.525  
NELLIS DEP/APP EAST  
384.400  
BLACKJACK  
377.800

**DREAM**  
N3710.34  
W11459.53

**MINTT**  
LAS 351/38  
17,000

**JUNNO**  
BLD 346/44  
17,000

Rwy	Knots	60	120	180	240	300	360
* 3 L (A)	V/V(fpm)	269	538	807	1076	1345	1614
* 3 R (B)	V/V(fpm)	245	490	735	980	1225	1470
† 3 L (C)	V/V(fpm)	498	996	1494	1992	2490	2988
† 3 R (C)	V/V(fpm)	496	992	1488	1984	2480	2976
* 21 L (D)	V/V(fpm)	389	778	1167	1556	1945	2334
* 21 R (D)	V/V(fpm)	395	790	1185	1580	1975	2370
† 21 L (C)	V/V(fpm)	453	906	1359	1812	2265	2718
† 21 R (C)	V/V(fpm)	457	914	1371	1828	2285	2742

\* Minimum † ATC Climb Rate

- (A) to 3600
  - (B) to 3100
  - (C) to 17,000
  - (D) to 8500
- \*\* Lead DME:  
ATALF - LSV 9.5  
HEREM - LSV 8.8

- ① 12.24 NM from Rwy 21R
- ② 12.40 NM from Rwy 21L
- ③ 5.67 NM from Rwy 3L
- ④ 5.85 NM from Rwy 3R

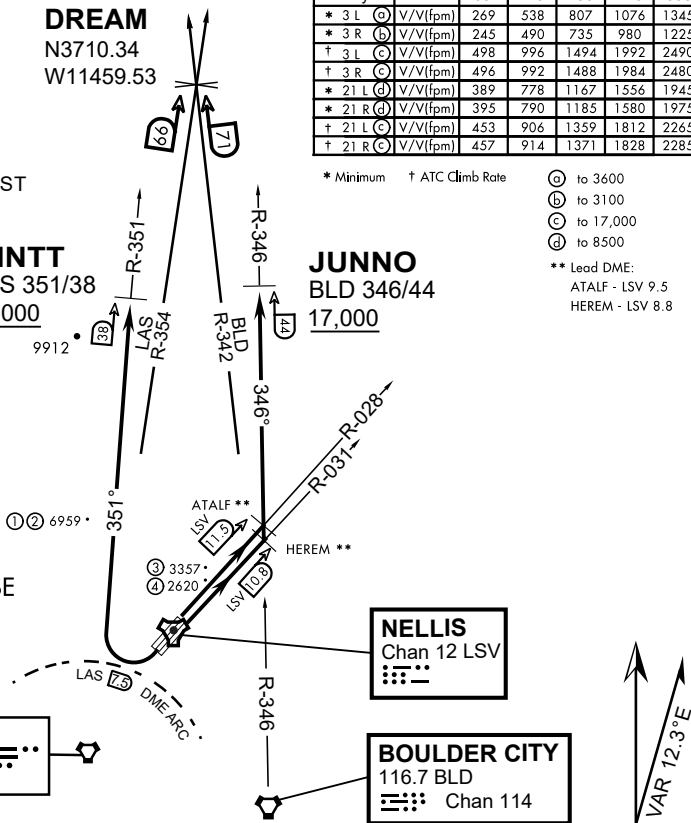

## NOT FOR CIVIL USE

CAUTION: If unable to comply with restrictions advise ATC prior to departure.

LAS VEGAS  
116.9 LAS  
Chan 116

**NELLIS**  
Chan 12 LSV

**BOULDER CITY**  
116.7 BLD  
Chan 114

VAR 12.3°E

## DEPARTURE ROUTE DESCRIPTION

### TAKE-OFF RWY 3L

- Fly runway heading to intercept the LSV TACAN R-028 then direct ATALF, intercept the BLD VORTAC R-346 then direct JUNNO, cross JUNNO at or above 17,000, then via assigned route.

### TAKE-OFF RWY 3R

- Fly runway heading to intercept the LSV TACAN R-031 then direct HEREM, intercept the BLD VORTAC R-346 then direct JUNNO, cross JUNNO at or above 17,000, then via assigned route.

### TAKE-OFF RWY 21L/R

- Turn right to intercept LAS VORTAC R-351 outbound. Remain North of LAS 7.5 DME turning Northbound. Intercept LAS R-351 between 5000 and 6000, do not proceed West of LAS R-351. Cross MINTT at or above 17,000, then via assigned route.

NOISE ABATMENT PROCEDURES: Fly acc. Nellis Noise Abatement instructions

# DREAM FOUR DEPARTURE (DREAM4 • DREAM)





INDIAN SPRINGS, NEVADA

TACAN INS Chan 87	APCH CRS 294 °	Rwy Idg TDZE Arprt Elev	9002 3133 3113
----------------------	-------------------	-------------------------------	----------------------

INDIAN SPRINGS AF AUX (KINS)

**▽** \* MISSED APPROACH: Direct INS then outbound INS **t8:2#DME** climbing to 10,000.

NELLIS CON -	INDIAN SPRINGS TOWER 118.30 <b>U</b> 60.60	GND CON -
-----------------	---	--------------

**NOT FOR CIVIL USE**

5975 •

**CAUTION:** Final approach course does not cross Runway centerline prior to threshold. Maneuvering right of course required prior to landing.

CREECH AFB  
Chan 87 INS

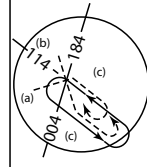
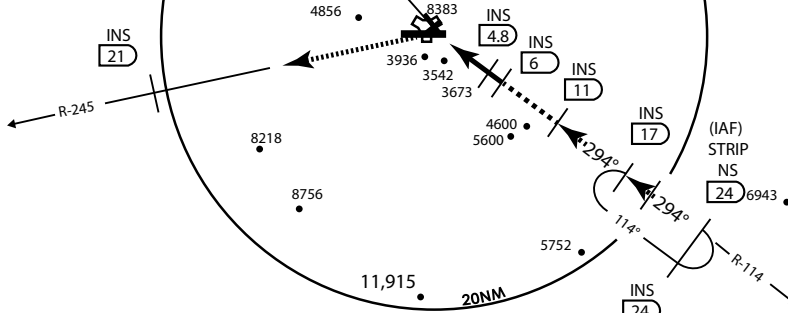

Modified by vJaBoG 66 for use with DCS

Modified by vJaBoG 66 for use with DCS

NOT FOR REAL LIFE NAVIGATION

\* CAUTION: Missed Approach Climb Rate to 4,700

Knots	60	120	180	240	300	360
V/V (fpm)	450	900	1350	1800	2250	2700

Controlling Obstacle 3936

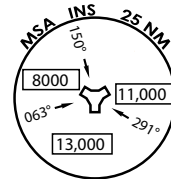

EMERG SAFE ALT 100 NM 14,000

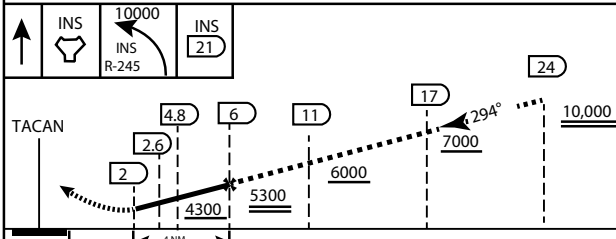

ELEV 3129

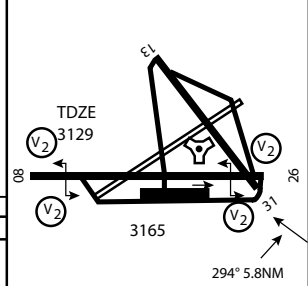

CATEGORY	A	B	C	D	E
S-26	3800-2 ¼	697 (700 2 ½)			3800-2 ¼ 697 (700-2 ½)
CIRCLING	NOT AUTHORIZED				

MIRL Rwy 8-26 **0**

CITY OF INDIAN, NEVADA

INDIAN SPRINGS AF AUX (KINS)



# AIRPORT DIAGRAM

476 VFG

CREECH AFB (KINS)  
INDIAN SPRINGS, NEVADA

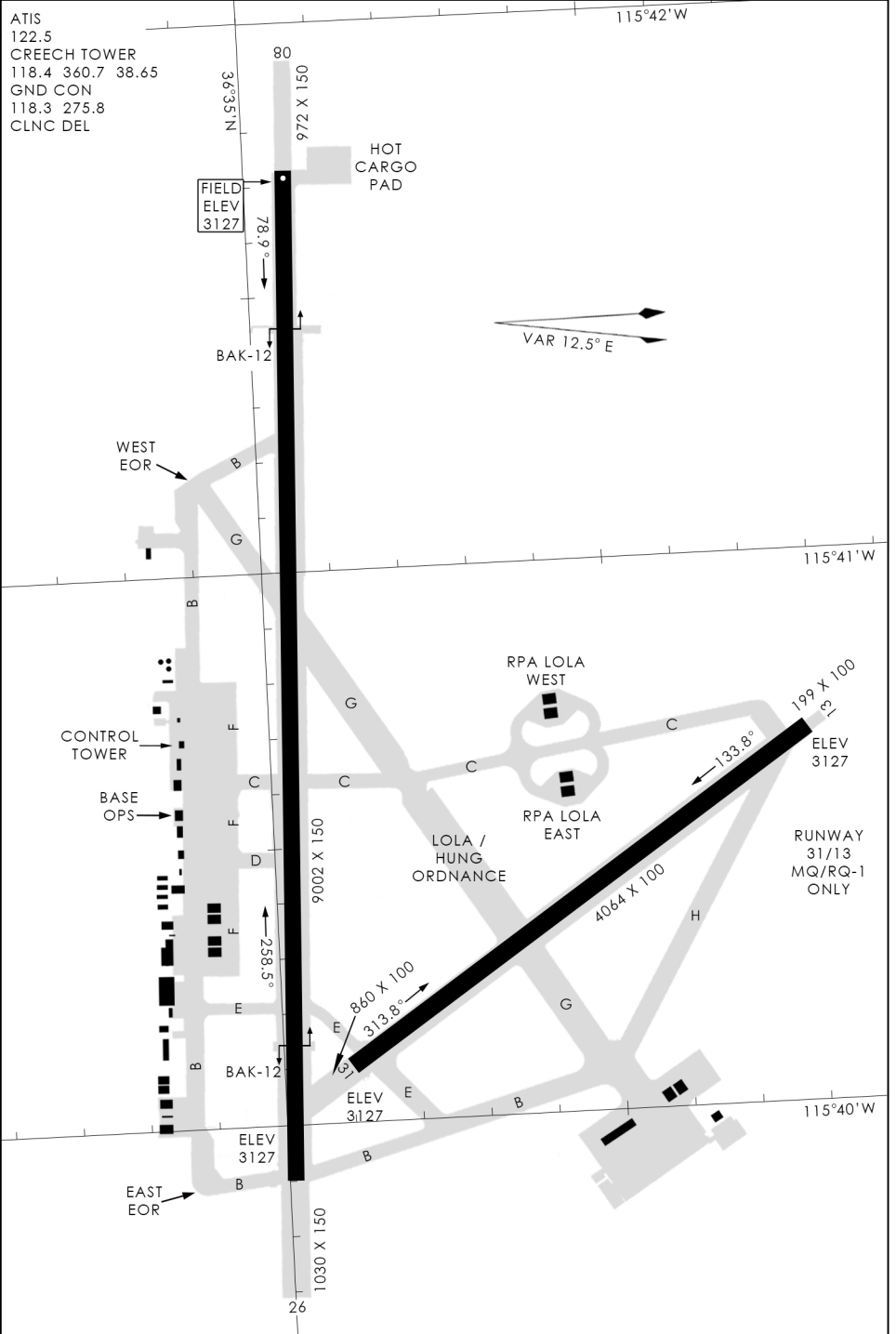

476 VFG JAN 2019

476 VFG JAN 2019

# AIRPORT DIAGRAM

INDIAN SPRINGS, NEVADA  
CREECH AFB (KINS)